



(425) 652-6515
www.Hergert.com
Kevin @ Hergert.com
Wa. Home Inspector 619
WSDA Inspector 79988
WSDA Control # 11124AQ-016



Client: XXXXXXXXXXXXXXXX
Address: XXXXXXXXXXXXXXXX

Property Description: (2) story single family home with daylight basement
Estimated property age: Built 1996 per listing
Occupancy Status: Occupied (staged)

Inspection Date: 08/11/2019
Inspection Time: 12:00 P.M. - 2:30 P.M. +-
Weather Conditions: Overcast, 70 deg f +-

Hergert Inspection LLC

Kevin Hergert, Member

Table of Contents

Summary of Inspection	3
Electrical System	6
Plumbing	8
Heating System	10
Water Heater	13
Site	15
Building Exterior	17
Crawlspace/ Storage.....	23
Garage	25
Living Room and Sitting Area	27
Kitchen and Dining Area	28
Powder Room.....	30
Hallways	31
Master Bedroom Suite	33
Bedrooms 2, 3, and 4	35
Main Bathroom	36
Laundry Room	37
Family Room	38
Basement Bedroom.....	40
Basement Bathroom.....	42
Attic.....	43
Structural Pest Inspection Diagram	45

Summary of Inspection

All items listed in the Summary of each section are listed below. Additional comments may be written in the body of the report. Please read the entire report. All items listed below should be further evaluated, inspected, modified, and/or corrected by a licensed professional in that corresponding or related trade.

WDO refers to “Wood Destroying Organism” as defined by the Washington State Department of Agriculture. “Satisfactory” is defined as the item serving its intended purpose

- Items in this font are general comments throughout report.

Electrical System

Plumbing

- The supply lines to most of the bathroom sinks are polybutylene pipe. This type of pipe is a known defect as it tends to fail. Recommend replacement (this does not involve changing pipes within the wall)

Heating System

- The age of the furnace is 23 years. The remaining anticipated useful life expectancy is 2 years. The age of the air conditioning compressor is 15 years
- Recommend furnace and air conditioning systems to be cleaned, serviced, and shown to be in good working order by a qualified furnace technician. The last service date for the systems was in 2015 per the tag on the furnace
- The air conditioning system compressor is not level which can result in premature wear of the system

Water Heater

- The water heater is fully functional with no visible evidence of rusting, however is past the end of its anticipated useful life expectancy by 1 year
- New water heater tank installations typically require an expansion tank be installed. The tank absorbs pressure as hot water expands. It appears that a prior expansion tank has been removed

Site

- Ground in contact with the siding (WDO conducive condition). Recommend 4-6” separation between the ground and siding
- Recommend installing a drainage system at the front corner of the Living room sitting area that would divert water away from the home and prevent water from splashing back onto the siding
- There is substantial settlement of the front porch and walkway. A trip hazard exists due to the raised edges at the slabs
- Seller should demonstrate that the irrigation system operates as designed and explain all winterization procedures as may be applicable. Some irrigation heads appear to be damaged

Building Exterior

- There is evidence of settlement of the front porch. No adverse issues to the structure were identified as a result of this settlement. The settlement is likely related to the settlement at the adjacent slabs
- There is evidence of siding failure where adjacent to the uncontrolled downspout located at the outer corner of the Living room sitting area

- The end joints of the siding should be caulked as needed
- The gutters should be cleaned of debris
- Once cleaned of debris, the slope of the gutter at the front porch should be verified. Settlement of this area may affect the slope of the gutters
- Seller: explain the dent located at the gutter located at the driveway side of the garage. An old moisture stain is visible at the siding in this location
- The rear hose bib appears to have an internal crack and substantially leaks into the adjacent wall when active. Recommend immediate review and repair by a licensed plumber (inspector turned off the water supply to the home as the sound of running water could be heard even with this valve set to the off position). See the related comments in the Basement bedroom section
- All gas pipes should be coated with rust proof paint
- There is evidence of wood rot at the top side of several barricade posts at the deck

Crawlspace/ Storage

Garage

Living Room and Sitting Area

- There does not appear to be an electrical outlet behind the staging TV that is located above the fireplace

Kitchen and Dining Area

- The dishwasher drain should be secured to the underside of the countertop to prevent cross contamination of waste water with the dishwasher (high loop)
- Seller: Is there a water supply to the refrigerator? If so, demonstrate this the supply and ice/water features of the refrigerator function as designed

Powder Room

Hallways

- Recommend replacement of all hallway area smoke detectors as they appear to be past their 10 year anticipated useful life expectancy
- Carbon monoxide detectors are not installed as per Wa.State law. A detector was not located at floor 1 or the basement
- The door to the basement does not latch
- *Horizontal barricades are permitted by code, however can be a fall safety hazard as the style creates a climbing ladder*

Master Bedroom Suite

- Recommend replacement of the smoke detector as it appears to be past its 10 year anticipated useful life expectancy
- The bedroom door does not latch
- The shower valve is difficult to turn off and intermittently drips

Bedrooms 2, 3, and 4

- Recommend replacement of the smoke detector in the West bedroom as it appears to be past its 10 year anticipated useful life expectancy

Main Bathroom

Laundry Room

Family Room

- There is evidence of substantive settlement of the slab located in this space. Seller: explain the history of this settlement. Recommend further review and cost estimates to repair by a licensed contractor. Self leveling concrete should be used as slab jacking may result in damage to the primary waste line for the home

Basement Bedroom

- There is evidence of active moisture intrusion at the outer corner of the bedroom. The source of the moisture appears to be the damaged hose bib located at the outer wall at this area. All moisture damaged insulation, drywall, and carpeting pad should be removed and replaced
- Recommend replacement of the smoke detector as it appears to be past its 10 year anticipated useful life expectancy

Basement Bathroom

Attic

Electrical System

Service

Type: Underground
Condition: Satisfactory
Meter Location: Side of garage

Panel

Location: Garage
Manufacturer: Square D
Type: Dual bus bar
Panel Rating: 200 AMP
Main Disconnect: 200 AMP
Serv. wire Size/ Rating: Estimated 200 AMP
Sub-panel: No
Grounding: To an exterior ground rod; limited visibility
Panel Clearance: 30" wide, 3' in front as required
Panel Cover: Satisfactory

Breakers/ Wiring

Type: Copper romex and multi-strand aluminum
Breakers: No visible defects
Circuit breaker legend: Appears proper and complete. Individual circuit breakers are not tested
-



Electrical panel

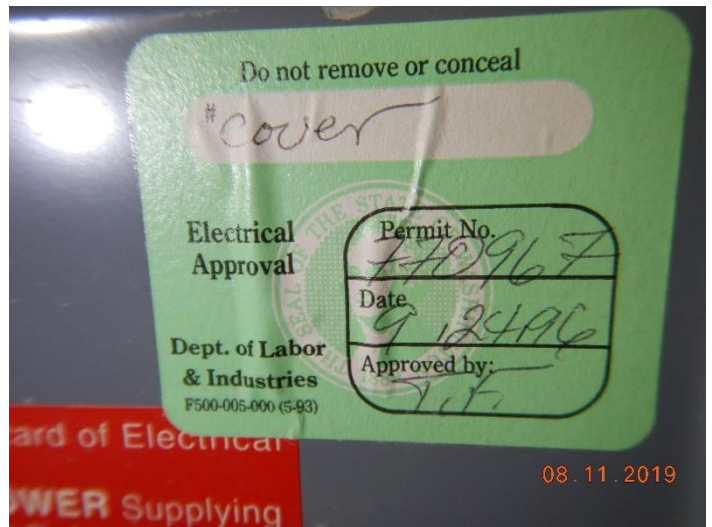

Electric service permit tag

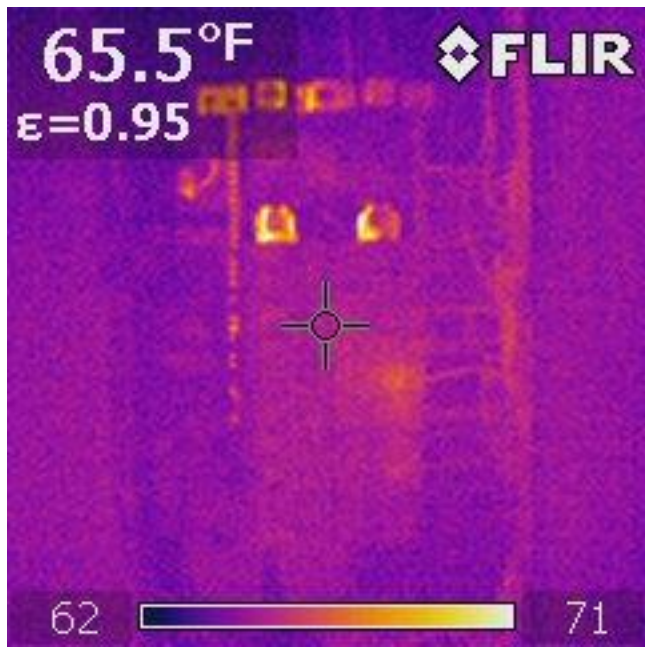

No evidence of overheating

Plumbing

Domestic Water

Supply: Public water per listing, not included in this inspection

Supply Pipe: Copper pipe where visible

House Piping: Copper and pex pipe where visible

- The supply lines to most of the bathroom sinks are polybutylene pipe. This type of pipe is a known defect as it tends to fail. Recommend replacement (this does not involve changing pipes within the wall)

Main Water Shut off: @ garage

Measured water pressure: 75 P.S.I. Water pressure is adequate and not excessive



Domestic Water Shut off



Polybutylene pipe @ sinks



Water pressure is adequate and not excessive

Sanitary Sewer

Discharge: Public sewer; not included in the inspection

House Piping: ABS where visible



ABS waste lines

Heating System

Furnace

Location: Garage
Make/ Model: Trane
Fuel Type: Natural gas
BTUH Input: Not noted
BTUH Output: Not noted on the furnace
Efficiency Rating: Mid-efficiency

Useful Life

Est. Useful Life new: 25 years
Serial number/year: Ansi 1993
Est. age of furnace: 23 years based on the age of construction of the home
Est remaining life: - The age of the furnace is 23 years. The remaining anticipated useful life expectancy is 2 years. The age of the air conditioning compressor is 15 years
Servicing: - Recommend furnace and air conditioning systems to be cleaned, serviced, and shown to be in good working order by a qualified furnace technician. The last service date for the systems was in 2015 per the tag on the furnace
- The air conditioning system compressor is not level which can result in premature wear of the system
- The inspection of the heat exchanger involves dismantling of the components of the furnace and is beyond the scope of a Home Inspection



Furnace

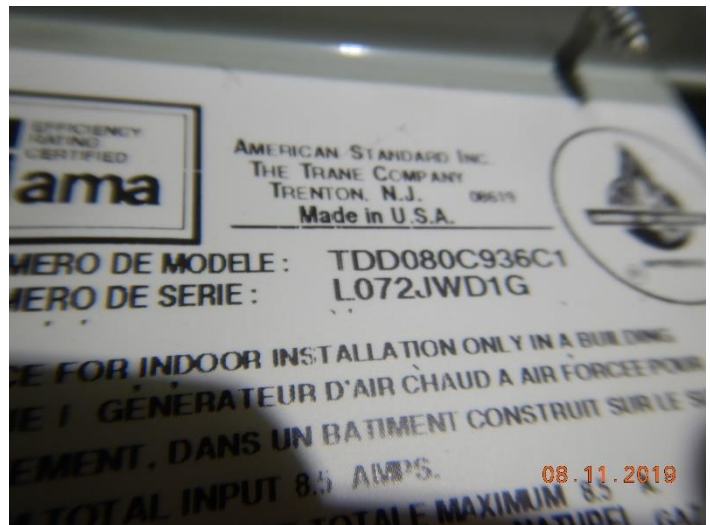

Data tag



The compressor is not level

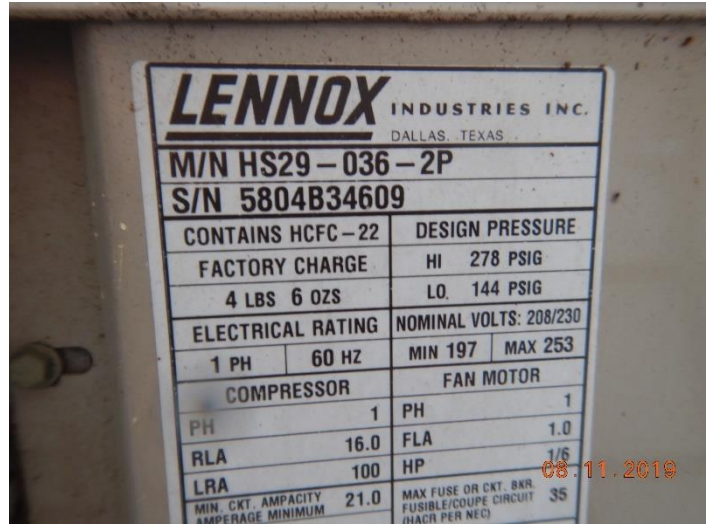

The compressor appears to be dated 2004

Operation

- Thermostat: Programmable @ floor 1
- Disconnect: Switch on wall adjacent to the furnace
- Combustion Air: Appears adequate
- Filter: Located above the furnace

Flue/ Gas Piping

- Flue condition: Satisfactory
- Flue clearances: Satisfactory

Heat Gain

- Rating: 35-65 deg F
- @ return air: 70 deg F
- @ nearest register: 109 deg F
- Heat Gain: 39 deg F. Heat gain is within specifications of the furnace

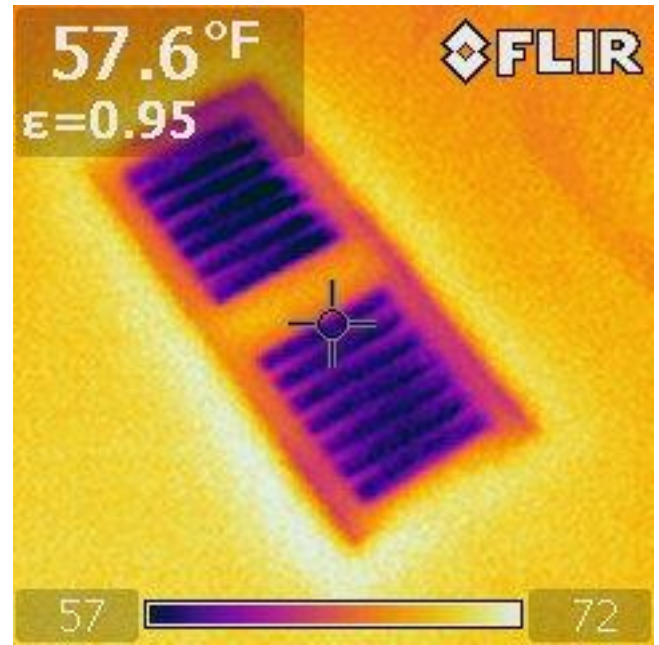
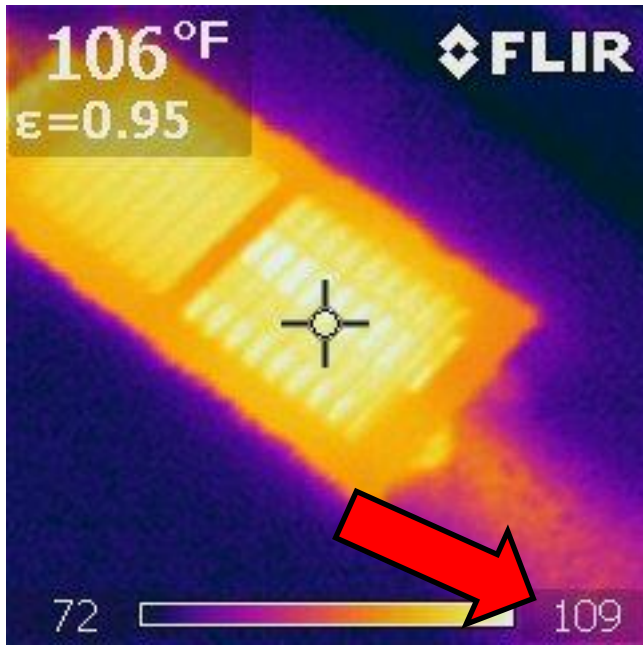

Water Heater

Water Heater

Location: Garage
Manufacturer: Rheem
Fuel Type: Natural gas
Capacity: 50 gallon



Water Heater

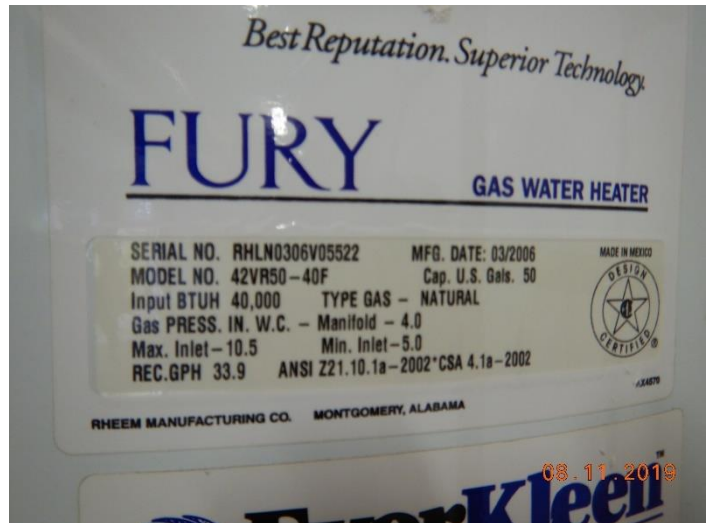

Data plate

Useful Life

Est. Useful Life new: 12 years
Serial number/year: 2006
Est. age of heater: 13 years based on the serial number
Est. remaining life: - The water heater is fully functional with no visible evidence of rusting, however is past the end of its anticipated useful life expectancy by 1 year

Gas venting and Plumbing

Flue secure: Inspected
Clearances: As required where visible
Draft Hood: Inspected
Water connection: Inspected
Expansion Tank: - New water heater tank installations typically require an expansion tank be installed. The tank absorbs pressure as hot water expands. It appears that a prior expansion tank has been removed
Drip pan: Installed

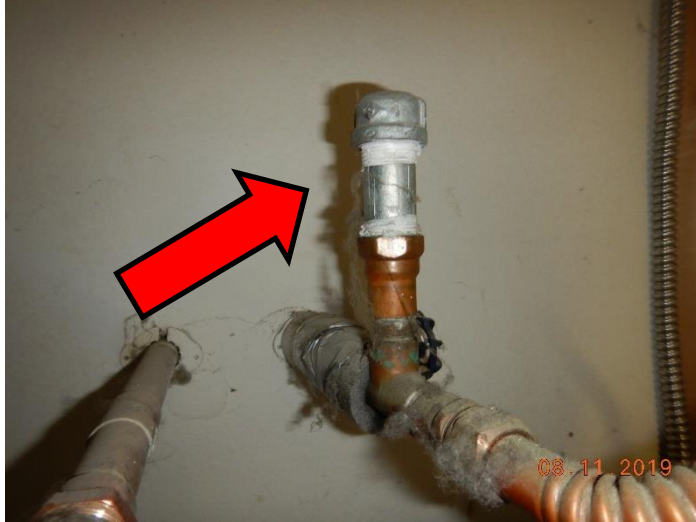

Appears that an expansion tank was removed from this location above the water heater

Safety

- TPR valve: As per required
- Earthquake Straps: Installed
- Safe water temperature: 120 deg F per industry standards
- Measured temperature: - *Temperature not measured*



Temperature setting

Site

Site

- Grade at structure: Adequate grade away
- Earth to wood contact: - Ground in contact with the siding (WDO conducive condition). Recommend 4-6" separation between the ground and siding
- Recommend installing a drainage system at the front corner of the Living room sitting area that would divert water away from the home and prevent water from splashing back onto the siding
- Vegetation contact: Negligible
- Roof drain discharge: Underground and surface discharge



Downspout chain. No splash-block or drain is provided (WDO conducive condition)



Ground in contact with the siding (WDO conducive condition)

Driveway

- Type: Concrete
- Condition: Satisfactory
- Trip Hazard: None

Front walks/ steps

- Type: Concrete
- Condition: Satisfactory
- Trip Hazard: - There is substantial settlement of the front porch and walkway. A trip hazard exists due to the raised edges at the slabs



Trip hazard

Rear walks/ steps

Type: Concrete
Condition: Satisfactory
Trip Hazard: None

Miscellaneous

House Identification #: Visible
Overhead Power Lines: No
Retaining Walls: None that affect structure
Underground Oil Tank: No visible evidence
Irrigation System: - Seller should demonstrate that the irrigation system operates as designed and explain all winterization procedures as may be applicable. Some irrigation heads appear to be damaged



Damaged irrigation head

Building Exterior

General Condition

- Structural Movement: - There is evidence of settlement of the front porch. No adverse issues to the structure were identified as a result of this settlement. The settlement is likely related to the settlement at the adjacent slabs
- Exterior doors: Satisfactory
- Windows (ext. cladding): Satisfactory

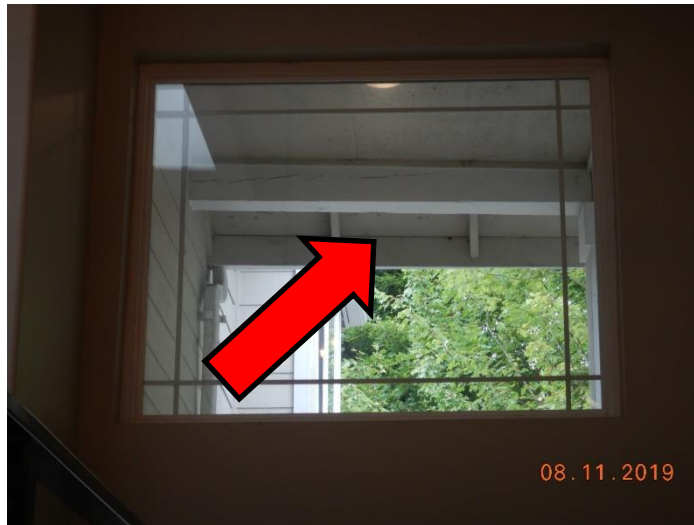

Evidence of settlement (sloping beam)

Siding and Vents

- Type: Composite
- Condition: Overall satisfactory
- There is evidence of siding failure where adjacent to the uncontrolled downspout located at the outer corner of the Living room sitting area
- Window/Door Flashing: Satisfactory
- Paint and caulking: - The end joints of the siding should be caulked as needed
- Exterior vents: Satisfactory



Gaps at the end joints should be caulked



Failed siding at the Living room area

Roof

Estimated Pitch: 5:12
Material: Composition
Layers: 1+
How Inspected: From floor 2, the street, rear yard, and a drone
Roof access condition: Roof was not traversed as traversing the roof is deemed unsafe by the inspector
Condition: Overall satisfactory
Ventilation: Eave and roof hat vents
Plumbing Vents: Satisfactory
Flues: Satisfactory
Flashing: Satisfactory



Skylight



Roof (typical)



Roof (typical)



Furnace flue

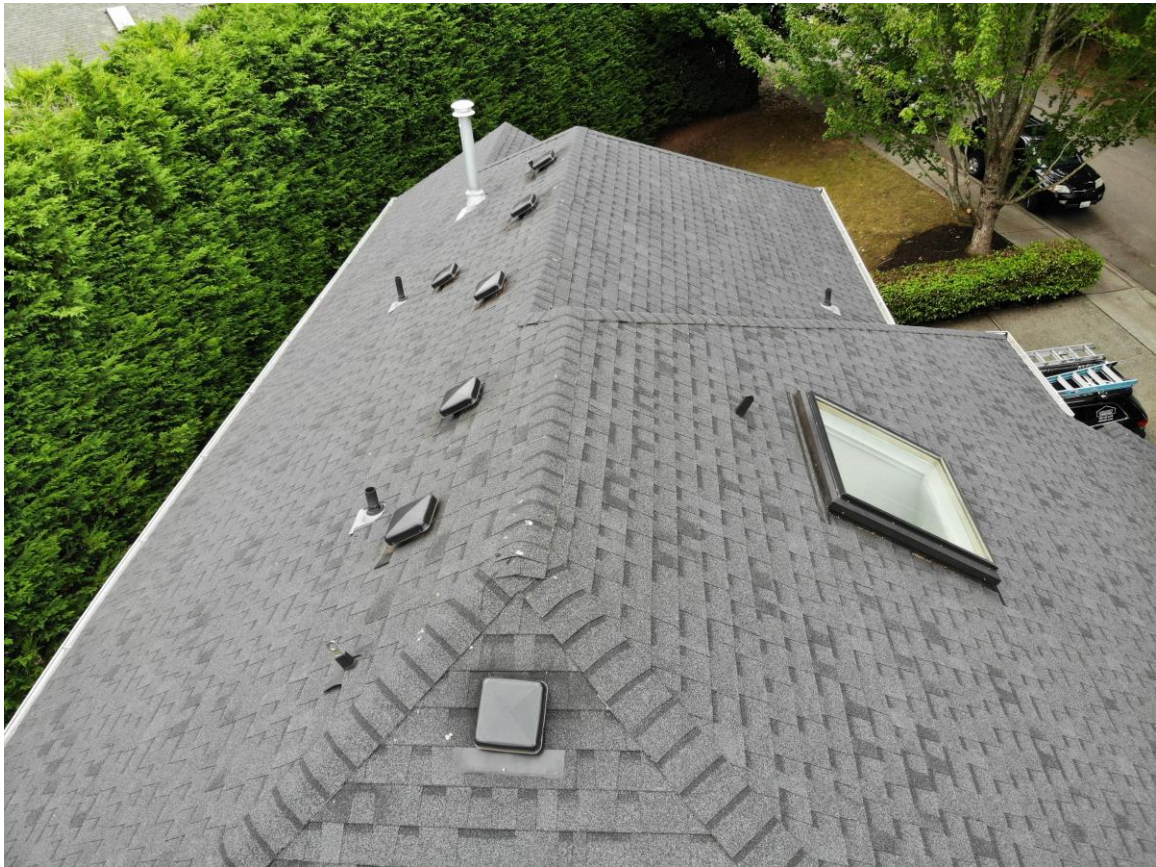

High ridge

Gutters/ Downspouts

- Type: Continuous metal
- Condition:
- The gutters should be cleaned of debris
 - Once cleaned of debris, the slope of the gutter at the front porch should be verified. Settlement of this area may affect the slope of the gutters
 - Seller: explain the dent located at the gutter located at the driveway side of the garage. An old moisture stain is visible at the siding in this location



Debris in the gutter above the entryway



Debris at an upper rear gutter



A downspout at the rear of the home is crushed, however appears to service its intended purpose



Dented gutter

Electrical

- Switches/Lights: A representative number of lights were tested
Comment: Exterior lights activated by motion and/or darkness are not tested
- Outlets: A representative number of visible and accessible outlets were tested for proper polarity and grounding
A representative number of exterior electrical outlets were tested for proper GFCI protection

Plumbing

- Hose Bibs: Satisfactory
- Gas Piping: - The rear hose bib appears to have an internal crack and substantially leaks into the adjacent wall when active. Recommend immediate review and repair by a licensed plumber (inspector turned off the water supply to the home as the sound of running water could be heard even with this valve set to the off position). See the related comments in the Basement bedroom section
- All gas pipes should be coated with rust proof paint



Water running from the siding at the rear hose bib



Rusting gas pipes

Decks

- Structure: Pressure treated joists, beams, and posts
- Decking: Cedar
- Condition: Overall satisfactory
- There is evidence of wood rot at the top side of several barricade posts at the deck
- Connection to structure: The deck appears to be adequately secured to the home with lag bolts
- Trip Hazard: None identified
- Handrails: A reasonable graspable handrail is installed
- Barricades: A reasonable barricade is installed



The deck is lag bolted to the home



Rotting barricade post (typical)

Crawlspace/ Storage

The crawlspace is inspected with access as defined as per the Washington State Standards of Practice. Areas that are not reasonably or safely accessible are not inspected. Insulation is not removed as a part of this inspection.

General

Visibility: Space is vacant
Access location: Basement
How viewed: Traversed entire crawlspace where accessible as per the Washington State standards of practice
Tip: Recommend a visual observation of the crawlspace at least twice per year to check for moisture, rodents, disconnected heating ducts, plumbing leaks, or other defects

Moisture

Ventilation: Appears adequate
Vapor Barrier: As required
Moisture Intrusion: No visible evidence
Sump Pump: None visible

Structural

Foundation: No substantive visible defects. Minor foundation cracks are typical
Mudsill: No visible defects, limited visibility
Joists: No visible defects; limited visibility
Post-Beams: Satisfactory
Structural Movement: No visible evidence

Insulation

Under-floor: Satisfactory
Domestic Water Pipes: Satisfactory
Heating Supply: Satisfactory

Plumbing

Waste lines: Satisfactory
Domestic water lines: Satisfactory
Valves/ Other: None visible

Electrical

Outlets: Not tested
Wiring/ junction boxes: No visible defects

Heating/ Ventilation

Duct Work: No visible defects
Ventilation Ducts: No visible defects
Gas Piping: No visible defects

Structural Pests

Conducive conditions: No visible evidence
Visible Evidence: No visible evidence

Nuisance Pests

Visible Evidence: No visible evidence

Tip: Rodents are a common problem in crawlspaces. Recommend a proactive approach by setting rodent traps

Garage

Location: Attached

All components of the garage tested for proper function and condition as related to the age and overall condition of the home. Personal belongings are not moved during the inspection; therefore, all areas and components may not be visible or tested.

General Room Condition

Visibility: Space is vacant
Structural Movement: No visible evidence of substantive structural movement
Moisture Intrusion: No visible evidence
Walls: Satisfactory
Ceiling: Satisfactory
Slab: Satisfactory. Minor horizontal shrinkage cracks are typical and not a concern

Safety

Sources of ignition: All 18" or more above the slab where required
Safety bollard: There is no need for a bollard as there is no substantive risk of vehicular impact with the mechanical equipment
Fire separation: There appears to be reasonable fire separation between the garage to the living spaces

Garage Door

Type: Metal roll up
Door condition: The doors are in satisfactory condition
Springs and tracks: The springs and tracks appear to be in satisfactory condition
Garage door openers: Yes
Auto reverse of impact: Reversed when reasonable force was applied
Photo cell reverse sensors: Tested for proper operation

Electrical

Switches/Lights: All visible tested
Outlets: All visible and accessible outlets were tested for proper polarity and grounding
Garage electrical outlets tested for proper GFCI protection
Tip: it is not recommended to plug a freezer into a GFCI electrical outlet as the motor may trip the GFCI circuit

Heating and Venting

Heat ducts: Satisfactory

Exterior Doors

Operation/latching: Tested for proper operation and latching
Door condition: Satisfactory

Plumbing

Domestic waste lines: There is no evidence of leakage at the plumbing waste lines located within the garage

Domestic water lines: There is no evidence of leakage at the domestic water lines located in the garage

Living Room and Sitting Area

Location: Floor 1

All components of this area are tested for proper function and condition as related to the age and overall condition of the home. Personal belongings are not moved during the inspection; therefore all areas and components may not be visible or tested.

General Room Condition

Visibility: Rooms are occupied
Structural Movement: No visible evidence of substantive structural movement
Moisture Intrusion: No visible evidence
Walls: Satisfactory
Ceiling: Satisfactory
Flooring: Satisfactory

Electrical

Switches/Lights: All visible tested
Outlets: All visible and accessible outlets were tested for proper polarity and grounding
- There does not appear to be an electrical outlet behind the staging TV that is located above the fireplace
Tip: some electrical outlets may be controlled by a wall switch

Heating and Venting

Source: Forced air register
Air Flow/ Heat Gain: Appears to be satisfactory

Windows

Glazing: No visible defects
Operation: The windows operate as intended
Screen: No substantive visible defects
The electric shades at the windows were tested

Doors/Millwork

Millwork condition: Satisfactory

Fireplace

Type: Direct vent gas fireplace
Tip: the inside of the glass cover of sealed direct vent gas fireplaces tends to become dirty over time. The glass can be removed for cleaning purposes. All gas valves should be in the Off position during removal of the glass and cleaning
Tested: Ignition of the fireplace
Condition: Satisfactory where visible

Kitchen and Dining Area

Location: Floor 1

All components of the Kitchen are tested for proper function and condition as related to the age and overall condition of the home. Personal belongings are not moved during the inspection; therefore all areas and components may not be visible or tested.

General Room Condition

Visibility: Rooms are occupied
Structural Movement: No visible evidence of substantive structural movement
Moisture Intrusion: No visible evidence
Walls: Satisfactory
Ceiling: Satisfactory
Flooring: Satisfactory
Cabinets: Satisfactory
Countertops: Satisfactory

Electrical

Switches/Lights: All visible tested
Outlets: All visible and accessible outlets were tested for proper polarity and grounding
Kitchen outlets tested for proper GFCI protection

Appliances

Dishwasher: Tested a full cycle. Not all functions and settings are tested
Dishwasher drainage: - The dishwasher drain should be secured to the underside of the countertop to prevent cross contamination of waste water with the dishwasher (high loop)
Cooktop: Tested all burners
Oven: Tested. Not all functions and settings are tested
Microwave (door): The door of the microwave was tested for operation
Ventilation: Tested
Refrigerator: - Seller: Is there a water supply to the refrigerator? If so, demonstrate this the supply and ice/water features of the refrigerator function as designed



Dishwasher drain

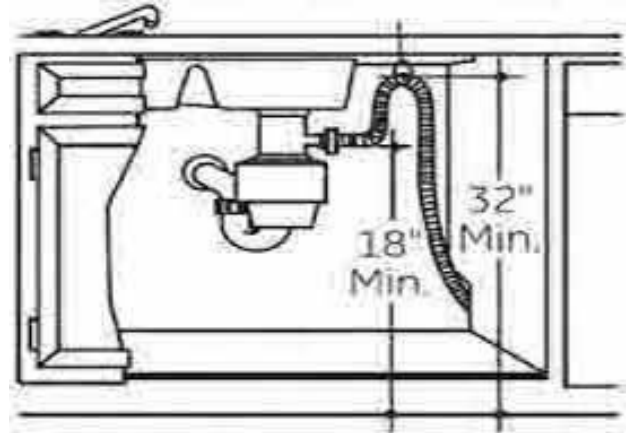

Proper dishwasher drain high loop

Heating

Source: Forced air register
Air Flow/ Heat Gain: Appears to be satisfactory

Windows

Glazing: No visible defects
Operation: The windows operate as intended
Screen: No substantive visible defects
The electric shades at the windows were tested

Doors/Millwork

Operation/latching: Tested for proper operation and latching
Door condition: Satisfactory
Millwork condition: Satisfactory

Plumbing

Overall functional flow: Appears adequate
Sink: No visible defects or leakage identified
Garbage disposal: Tested for proper operation

Powder Room

Location: Floor 1

All components of the bathroom are tested for proper function and condition as related to the age and overall condition of the home. Personal belongings are not moved during the inspection; therefore all areas and components may not be visible or tested.

General Room Condition

Visibility: Room is occupied
Structural Movement: No visible evidence of substantive structural movement
Moisture Intrusion: No visible evidence
Walls: Satisfactory
Ceiling: Satisfactory
Flooring: Satisfactory
Cabinets: Satisfactory
Countertops: Satisfactory
Mirrors: Satisfactory

Electrical

Switches/Lights: All visible tested
Outlets: All visible and accessible outlets were tested for proper polarity and grounding
Bathroom outlets tested for proper GFCI protection

Heating and Venting

Source: Forced air register
Air Flow/ Heat Gain: Appears to be satisfactory
Mechanical ventilation: Tested the operation of the fan motor

Windows

Glazing: No visible defects
Operation: The windows operate as intended
Screen: No substantive visible defects

Doors/Millwork

Operation/latching: Tested for proper operation and latching
Door condition: Satisfactory
Millwork condition: Satisfactory
Bath Hardware: Satisfactory

Plumbing

Overall functional flow: Appears adequate
Sink(s): No visible defects or leakage identified
Toilet: No visible defects or leakage identified

Hallways

Location: Floors 1, 2, and basement

All components of this area are tested for proper function and condition as related to the age and overall condition of the home. Personal belongings are not moved during the inspection; therefore all areas and components may not be visible or tested.

General Room Condition

Visibility: Space is occupied
Structural Movement: No visible evidence of substantive structural movement
Moisture Intrusion: No visible evidence
Walls: Satisfactory
Ceiling: Satisfactory
Flooring: Satisfactory

General comment: Flooring covered by rugs or furniture may discolor at a different rate than uncovered flooring. Personal belongings, including rugs, are not moved during an inspection

Electrical

Switches/Lights: All visible tested
Outlets: All visible and accessible outlets were tested for proper polarity and grounding
Tip: Some lights may be controlled by several light switches. As a result, the On position for a switch may not always be in the Up position
Doorbell: Tested
Smoke detector: - Recommend replacement of all hallway area smoke detectors as they appear to be past their 10 year anticipated useful life expectancy
CO Detectors: - Carbon monoxide detectors are not installed as per Wa.State law. A detector was not located at floor 1 or the basement
- RCW 19.27.530 Carbon monoxide ... for any owner-occupied single-family residence that is sold on or after July 26, 2009, the seller must equip the residence with carbon monoxide alarms in accordance with the requirements of the state building code before the buyer or any other person may legally occupy the residence following such sale. An approved carbon monoxide alarm shall be installed outside of each separate sleeping area in the immediate vicinity of the bedrooms in dwelling units and on each level of the dwelling and in accordance with the manufacturer's recommendations.

Windows

Glazing: No visible defects
Operation: Fixed
Skylight: Satisfactory

Doors/Millwork

Operation/latching: - The door to the basement does not latch
Door condition: Satisfactory
Millwork condition: Satisfactory

Stairwell

Graspable handrails: A reasonable graspable handrail is installed

Barricades: - *Horizontal barricades are permitted by code, however can be a fall safety hazard as the style creates a climbing ladder*

Trip hazard: Satisfactory



Horizontal barricade

Master Bedroom Suite

Location: Floor 2

All components of the bedroom and bathroom are tested for proper function and condition as related to the age and overall condition of the home. Personal belongings are not moved during the inspection; therefore all areas and components may not be visible or tested.

General Room Condition

Visibility: Room is occupied
Structural Movement: No visible evidence of substantive structural movement
Moisture Intrusion: No visible evidence
Walls: Satisfactory
Ceiling: Satisfactory
Flooring: Satisfactory
Cabinets: Satisfactory
Countertops: Satisfactory
Mirrors: Satisfactory

Electrical

Switches/Lights: All visible tested
Outlets: All visible and accessible outlets were tested for proper polarity and grounding
Tip: some bedroom electrical outlets may be controlled by a wall switch
Bathroom outlets tested for proper GFCI protection
Smoke detector: - Recommend replacement of the smoke detector as it appears to be past its 10 year anticipated useful life expectancy

Heating and Venting

Source: Forced air register
Air Flow/ Heat Gain: Appears to be satisfactory
Mechanical ventilation: Tested the operation of the fan motor
Tip: bathroom ventilation fans (if available) should be operated for at least 20 minutes after a shower in order to remove the excess humidity. A timer type switch is a recommended

Windows

Glazing: No visible defects
Operation: The windows operate as intended
Egress: Appears to provide reasonable emergency egress
Screen: No substantive visible defects

Doors/Millwork

Operation/latching: - The bedroom door does not latch
Door condition: *The door to the toilet/shower area has been removed*
Millwork condition: Satisfactory
Bath Hardware: Satisfactory

Plumbing

Overall functional flow: Appears adequate

Sink(s): No visible defects or leakage identified

Bathtub-Shower: *No visible defects or leakage identified. The tub was tested to the overflow*
- **The shower valve is difficult to turn off and intermittently drips**

Shower Door: The shower door is in satisfactory condition

Comment: shower pans and shower doors within the house are not tested with a person inside, therefore actual conditions for usage are not tested

Toilet: No visible defects or leakage identified

Comment: plumbing fixture valves within the house are not tested. Some valves may leak once turned on and off or to another position

Bedrooms 2, 3, and 4

Location: Floor 2

All components of the bedroom and bathroom are tested for proper function and condition as related to the age and overall condition of the home. Personal belongings are not moved during the inspection; therefore all areas and components may not be visible or tested.

General Room Condition

Visibility: Room is occupied
Structural Movement: No visible evidence of substantive structural movement
Moisture Intrusion: No visible evidence
Walls: Satisfactory
Ceiling: Satisfactory
Flooring: Satisfactory

Electrical

Switches/Lights: All visible tested
Outlets: All visible and accessible outlets were tested for proper polarity and grounding
Smoke detector: - Recommend replacement of the smoke detector in the West bedroom as it appears to be past its 10 year anticipated useful life expectancy

Heating and Venting

Source: Forced air register
Air Flow/ Heat Gain: Appears to be satisfactory

Windows

Glazing: No visible defects
Operation: The windows operate as intended
Egress: Appears to provide reasonable emergency egress
Screen: No substantive visible defects

Doors/Millwork

Operation/latching: Tested for proper operation and latching
Door condition: Satisfactory
Millwork condition: Satisfactory

Main Bathroom

Location: Floor 2

All components of this bathroom are tested for proper function and condition as related to the age and overall condition of the home. Personal belongings are not moved during the inspection; therefore all areas and components may not be visible or tested.

General Room Condition

Visibility: Room is occupied
Structural Movement: No visible evidence of substantive structural movement
Moisture Intrusion: No visible evidence
Walls: Satisfactory
Ceiling: Satisfactory
Flooring: Satisfactory
Cabinets: Satisfactory
Countertops: Satisfactory
Mirrors: Satisfactory

Electrical

Switches/Lights: All visible tested
Outlets: All visible and accessible outlets were tested for proper polarity and grounding
Bathroom outlets tested for proper GFCI protection. This GFCI outlet controls all of the bathroom outlets within the house

Heating and Venting

Source: Forced air register
Air Flow/ Heat Gain: Appears to be satisfactory
Mechanical ventilation: Tested the operation of the fan motor

Doors/Millwork

Operation/latching: Tested for proper operation and latching
Door condition: Satisfactory
Millwork condition: Satisfactory
Bath Hardware: Satisfactory

Plumbing

Overall functional flow: Appears adequate
Sink(s): No visible defects or leakage identified
Bathtub-Shower: *No visible defects or leakage identified. The tub was tested to the overflow*
Shower Door: *The shower door has been removed*
Toilet: No visible defects or leakage identified

Laundry Room

Location: Floor 2

All components of the Utility room are tested for proper function and condition as related to the age and overall condition of the home. Personal belongings are not moved during the inspection; therefore all areas and components may not be visible or tested. The dryer vent is not tested unless a dryer is connected.

General Room Condition

Visibility: Room is occupied
Structural Movement: No visible evidence of substantive structural movement
Moisture Intrusion: No visible evidence
Walls: Satisfactory
Ceiling: Satisfactory
Flooring: Satisfactory
Cabinets: Satisfactory

Electrical

Switches/Lights: All visible tested
Outlets: All visible and accessible outlets were tested for proper polarity and grounding

Heating and Venting

Source: Adjacent spaces
Air Flow/ Heat Gain: Appears to be satisfactory
Mechanical ventilation: Tested the operation of the fan motor
Dryer venting: To the exterior where visible
Maintenance tip: Dryer vents should be kept clean of lint build up as they can become a fire hazard

Doors/Millwork

Operation/latching: Tested for proper operation and latching
Door condition: Satisfactory
Millwork condition: Satisfactory

Laundry Machines

Clothes washer: Tested a full cycle. Not all functions and settings are tested
Clothes dryer: Tested a full cycle. Not all functions and settings are tested

Family Room

Location: Basement

All components of this area are tested for proper function and condition as related to the age and overall condition of the home. Personal belongings are not moved during the inspection; therefore all areas and components may not be visible or tested.

General Room Condition

- Visibility: Room is occupied
- Structural Movement: - There is evidence of substantive settlement of the slab located in this space. Seller: explain the history of this settlement. Recommend further review and cost estimates to repair by a licensed contractor. Self leveling concrete should be used as slab jacking may result in damage to the primary waste line for the home
- Moisture Intrusion: No visible evidence
- Walls: Satisfactory
- Ceiling: Satisfactory
- Flooring: Satisfactory



Settlement of 2" +/-; expansion foam has been added. The carpeting was unsecured at the outer corner of the room

Electrical

- Switches/Lights: All visible tested
- Outlets: All visible and accessible outlets were tested for proper polarity and grounding
Tip: some electrical outlets may be controlled by a wall switch

Heating and Venting

- Source: Forced air register
- Air Flow/ Heat Gain: Appears to be satisfactory

Windows

Glazing: No visible defects
Operation: The windows operate as intended
Screen: No substantive visible defects

Doors/Millwork

Operation/latching: Tested for proper operation and latching
Door condition: Satisfactory
Millwork condition: Satisfactory

Basement Bedroom

Location: Basement

All components of the bedroom and bathroom are tested for proper function and condition as related to the age and overall condition of the home. Personal belongings are not moved during the inspection; therefore all areas and components may not be visible or tested.

General Room Condition

- Visibility: Room is vacant
- Structural Movement: No visible evidence of substantive structural movement
- Moisture Intrusion: - There is evidence of active moisture intrusion at the outer corner of the bedroom. The source of the moisture appears to be the damaged hose bib located at the outer wall at this area. All moisture damaged insulation, drywall, and carpeting pad should be removed and replaced
- Walls: Satisfactory
- Ceiling: Satisfactory
- Flooring: Satisfactory



Mushroom growing from the carpeting

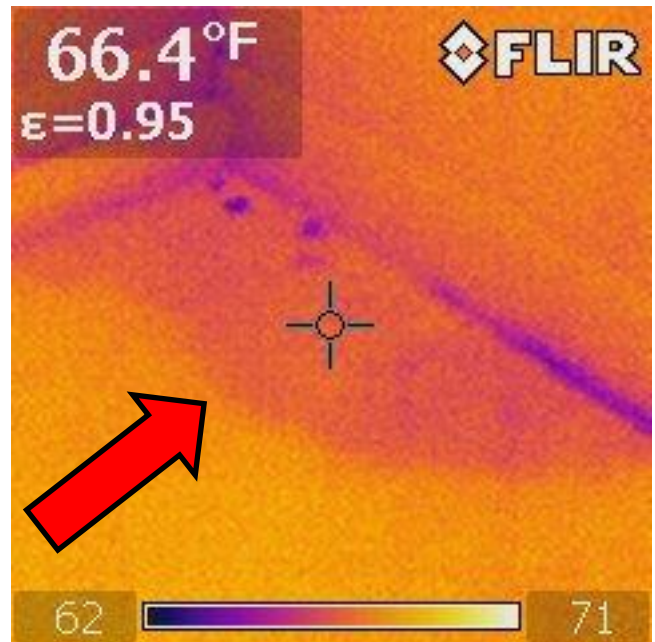

Moisture at the carpeting
(outer corner of the room)

Electrical

- Switches/Lights: All visible tested
- Outlets: All visible and accessible outlets were tested for proper polarity and grounding
- Smoke detector: - Recommend replacement of the smoke detector as it appears to be past its 10 year anticipated useful life expectancy

Heating and Venting

Source: Forced air register
Air Flow/ Heat Gain: Appears to be satisfactory

Windows

Glazing: No visible defects
Operation: The windows operate as intended
Egress: Appears to provide reasonable emergency egress
Screen: No substantive visible defects

Doors/Millwork

Operation/latching: Tested for proper operation and latching
Door condition: Satisfactory
Millwork condition: Satisfactory

Basement Bathroom

Location: Basement

All components of this bathroom are tested for proper function and condition as related to the age and overall condition of the home. Personal belongings are not moved during the inspection; therefore all areas and components may not be visible or tested.

General Room Condition

Visibility: Room is occupied
Structural Movement: No visible evidence of substantive structural movement
Moisture Intrusion: No visible evidence
Walls: Satisfactory
Ceiling: Satisfactory
Flooring: Satisfactory
Cabinets: Satisfactory
Countertops: Satisfactory
Mirrors: Satisfactory

Electrical

Switches/Lights: All visible tested
Outlets: All visible and accessible outlets were tested for proper polarity and grounding
Bathroom outlets tested for proper GFCI protection

Heating and Venting

Source: Forced air register
Air Flow/ Heat Gain: Appears to be satisfactory
Mechanical ventilation: Tested the operation of the fan motor

Doors/Millwork

Operation/latching: Tested for proper operation and latching
Door condition: Satisfactory
Millwork condition: Satisfactory
Bath Hardware: Satisfactory

Plumbing

Overall functional flow: Appears adequate
Sink(s): No visible defects or leakage identified
Bathtub-Shower: No visible defects or leakage identified
Toilet: No visible defects or leakage identified

Attic

Location: Over main body of house

General

Visibility: Space is vacant
Access location: Master Bedroom closet
How viewed: From the attic access as all accessible areas are visible from the access



Attic (typical)

Moisture

Roof Ventilation: Appears adequate
Moisture Intrusion: No visible evidence
Bathroom Vents: All vent to the outside where visible

Structural

Structure Type: Manufactured trusses
Sheathing: OSB
Structural Movement: No visible evidence

Insulation

Type: Blown in
Condition: Satisfactory

Flues/Vent Stacks

Plumbing Stacks: All vented to exterior
Gas Flues: Satisfactory

Electrical

Outlets: None visible
Wiring/ junction boxes: No visible defects

Structural Pests

Conducive Material: No visible evidence
Visible Evidence: No visible evidence

Nuisance Pests

Visible Evidence: No visible evidence

Structural Pest Inspection Diagram

Wood Destroying Organisms (WDO)

WDO-AB	Anobid Beetles
WDO-CA	Carpenter Ants
WDO-DT	Dampwood Termites
WDO-MA	Moisture Ants
WDO-OB	Other Beetles
WDO-RF	Rot Fungus
WDO-ST	Subterranean Termites

Conductive Conditions (CC)

CC-BG	Bare Ground
CC-CD	Conductive Debris
CC-EM	Excessive Moisture
CC-EW	Earth-Wood Contact
CC-FC	Failed Caulking
CC-IV	Inadequate Ventilation
CC-RG	Restricted Gutter
CC-VC	Vegetation Contact

Inspection Conditions (IC)

IC-CSA	Crawl Space Access
IC-IA	Inadequate Clearance

